

# Gas Oven Range

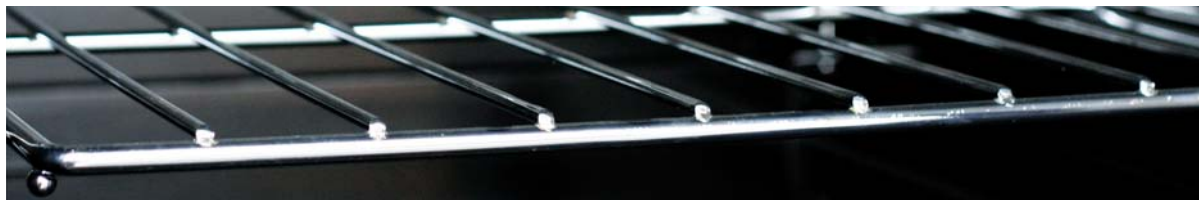

LKKOB4B+0



LKKOB4C+0



LKKOB4D+0

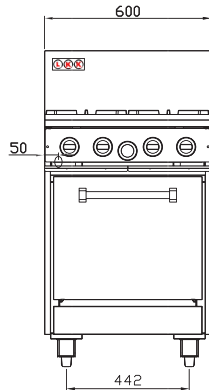
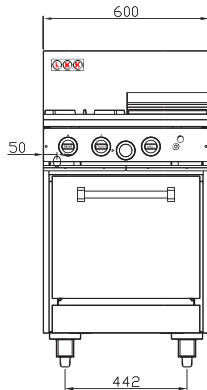
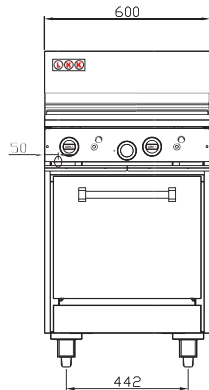
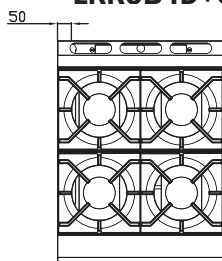
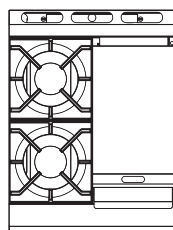
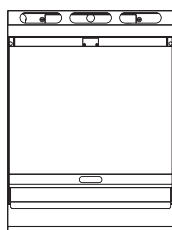

## Features:

- GasMark Certified.
- Free standing design.
- Height adjustable feet.
- Undershelf storage space.
- Flame failure safety device.
- Griddle plate thickness: 16mm.
- Hotplate is piezo & pilot ignition.
- Open burners are manual ignition.
- Rated at: 33MJ/hr per oven.  
20MJ/hr per grill burner.  
28MJ/hr per open burner.
- Removable: Burner cap.  
Spillage tray.  
Cast iron trivets.  
Griddle plate grease tray
- Heavy duty thermostat: 100 °C to 340 °C adjustable range
- Oven Dimensions: 490 x 590 x 375mm

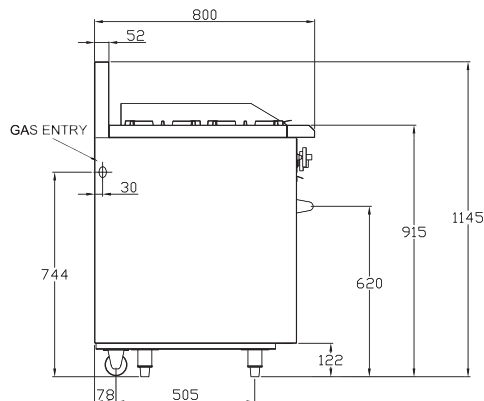

## Specification

Model	Natural Gas	LP Gas	Dimensions (W x D x H)
LKKOB4B+0	73MJ/h	73MJ/h	600mm x 800mm x 900mm (working height)
LKKOB4C+0	109MJ/h	109MJ/h	600mm x 800mm x 900mm (working height)
LKKOB4D+0	145MJ/h	145MJ/h	600mm x 800mm x 900mm (working height)

Height including splashback is 1260mm

**Accessories:** 2x Oven Rack Grill Only: Grease tray

**Inlet:** Gas: ¾" BSP

• Specifications and design are subject to change without notice • Pictures are for illustrative purposes only • 2015 July



**New Zealand** Phone: (+64) 09 837 2960 Fax: (+64) 09 836 9168  
(Head Office) 18 Paramount Drive, Henderson, Auckland  
www.lkk.co.nz sales@lkk.co.nz

**Australia** Phone: 1300 655 715 Fax: (+61) 02 8587 0033  
47 George St, Clyde Sydney, NSW 2142, Sydney  
www.lkk.com.au sales@lkk.com.au

Authorised Retailer: